



Jotun Protects Property

Jotafloor

PU CRETE

APPLICATION
GUIDE





TABLE OF CONTENTS

System Description	2
Scope & Standards	4
Application Limitation	6
Important Consideration for Application	8
Important Precautions and Special Considerations	12
Surface Preparation	14
Packaging and Coverage	20
Mixing	22
Shade Variations	24
Application	26
Equipment	30
Colours	32
Application Mistakes and Surface Defects	34
HSE	36
PPE	38
Cleaning and Maintenance	40
Caution & Disclaimer	42



SYSTEM DESCRIPTION



SYSTEM DESCRIPTION:

This product is a seamless, self-smoothing, solvent free polyurethane based hybrid antimicrobial flooring system. It has high impact resistance, sustains abrasion and resistant to many chemicals being used in day to day life.

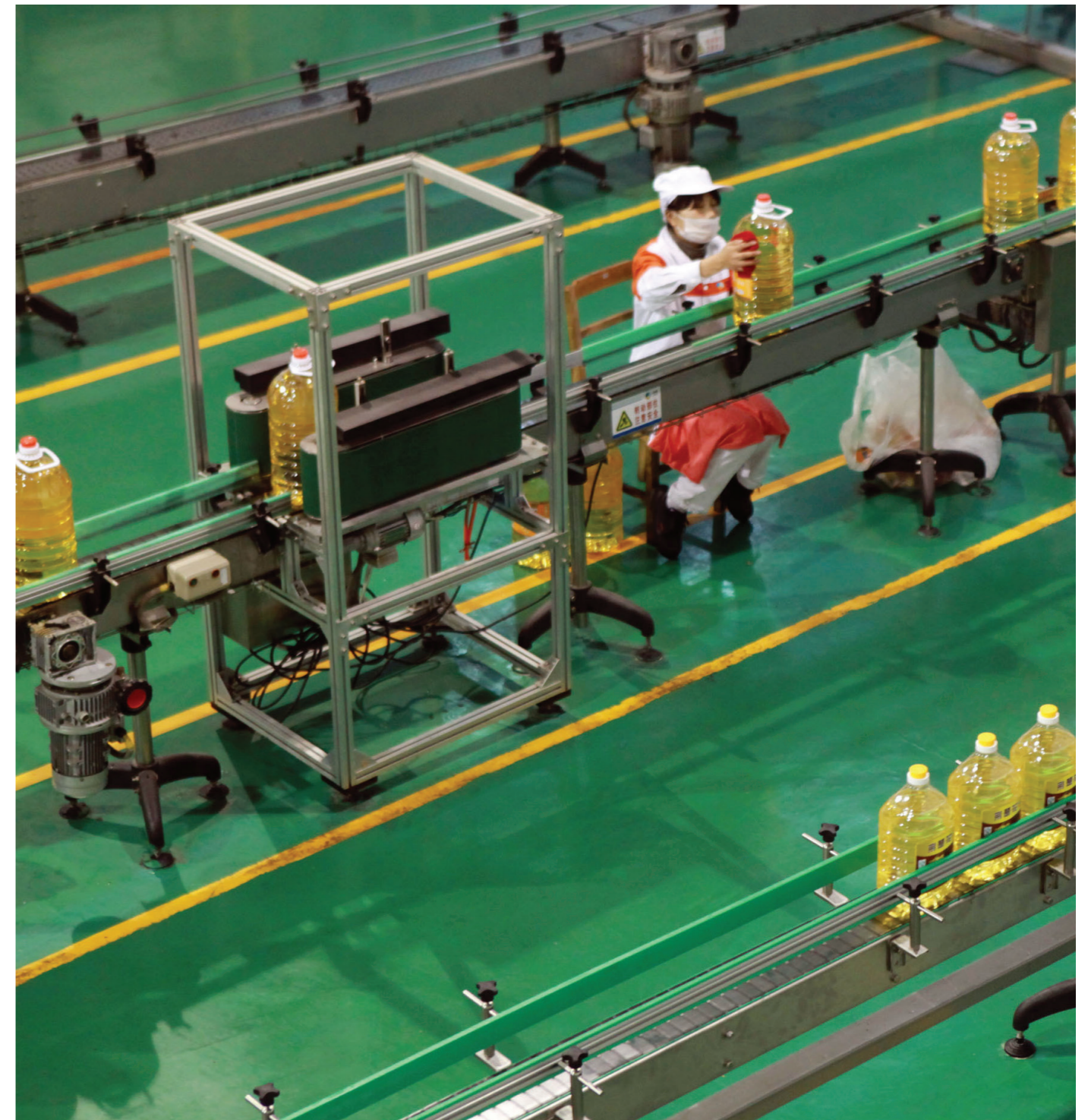



SCOPE & STANDARDS



SCOPE:

The method statement offers product details and recommended practices for the use of the product. This method statement must be read in conjunction with the relevant specification, Technical Data Sheet (TDS) and Safety Data Sheet (SDS) for all the products used as part of the coating system.

The method statement is a guide for flooring applicators in the installation of Jotafloor PU Crete. The successful installation of the product is the sole responsibility of the flooring applicator. The product application requires a high degree of skill, special tools and equipment. Jotafloor PU Crete is only available for installation by trained and experienced applicators.

STANDARDS:

Reference is generally made to ASTM, BS and SSPC Standards. When using standards from other regions it is recommended to reference only one corresponding standard for the substrate being treated.

Approved by



Complies with





APPLICATION LIMITATION



APPLICATION LIMITATION :

(i) Acceptable environmental conditions - before and during application

- **Evaluate the substrate for**
 - a) Age – Greater than 7 days
 - b) Compressive Strength – Greater than 25 MPa or 3626 psi
 - c) Cohesion – Greater than 1.5 MPa or 218 psi
- **The moisture content should not exceed 8%.**

Jotafloor PU Crete flooring system is extremely tolerant to residual substrate moisture and can be installed directly on to 7 day old concrete, or onto old good quality concretes. A damp-proof membrane is essential to prevent rising moisture as it may cause the concrete to become saturated and negative pressures to adversely affect the bond to the Jotafloor PU Crete flooring. Jotafloor PU Crete flooring system is impermeable to liquids but must not be used as a substitute for a membrane or vapor barrier.
- **The Relative Humidity should not exceed 80%**
 - a) The relative ambient humidity plays an extremely important role in the reaction during and after the application.
 - b) Environments with low relative humidity will delay the reaction and increases tack free times resulting in white bloom over the surface and will also delay the service time.
 - c) If the humidity is below 30% tack free times can extend for several days. If basecoats are overlaid before they are dry/tack free this can lead to blistering.
 - d) Application of Jotafloor PU Crete at higher humidity will lead to blisters in final appearance.
- **Minimum and maximum temperature should be 15°C and 27°C respectively.**
 - a) The higher the ambient temperature the quicker the reaction.
 - b) The lower the ambient temperature the slower the reaction
- **Do not apply Jotafloor PU Crete under direct sunlight or on to hot substrates.**

Application of Jotafloor PU Crete under direct sunlight will lead to blisters in final appearance.
- **Do not apply when the ambient temperature is more than 30 degrees.**
 - a) The reaction will be quick and will result in blisters in final appearance.
 - b) Laying Jotafloor PU Crete will also be a challenge as the pot life will be short.
- **Substrate temperature should be at least 3°C above the dew point.**

The substrate and uncured primer floor must be at least 3°C above dew point to reduce the risk of condensation or blooming on the floor finish.



IMPORTANT CONSIDERATION FOR APPLICATION



IMPORTANT CONSIDERATION FOR APPLICATION :

- **At high and low temperature**

- a) Ideal temperature for the application of Jotafloor PU Crete is 15° - 27° C.

- b) The challenges while installing below 15° C will be

- (i) Workability due to high viscosity
- (ii) Poor levelling
- (iii) Increased trowel and spike marks
- (iv) Increased curing time.

To overcome these challenges and improve the workability and ease the application it is required to reduce the viscosity of the material. This can be done by raising the temperature of the stocked material. The entire materials required for application can be placed under a tent or a covered area and can be heated using electrical radiators or hot air blowers. Do not use or recommend oil fired heaters as it may result in contamination of the material or the application area. This may further lead to failures.

- c) The challenges while installing above 27 degrees will be

- (i) Poor pot life
- (ii) Lesser time to lay down on to the floor
- (iii) Spike marks
- (iv) Blisters on the final finish

To overcome these challenges while working above 27 degrees, it is necessary to cool down the material prior to its application in order to increase the working and open time and thus reducing the chance of blistering due to excessively fast skin formation.

Storing the material in a climate controlled (air conditioned) chamber will allow to bring down the temperature prior to application. It is important to condition the materials at a temperature between 15° C to 23° C for 24 hours. (Check the next section below for more details on conditioning).

Alternatively placing parts A and B in ice water will also bring its temperature down but by ensuring that Part B does not meet water as it can react. This should be done just one hour prior to the application. The mixed temperature of component A and B should be not be less than 15 degrees. It is better to check the temperature using a thermometer before carrying out the application.

Note: To improve workability of Jotafloor PU Crete never remove any amount of component C from the mix to make it more resin rich. The required quantity is important part of the reaction and may cause the appearance of blisters or surface irregularities and pin holing. This action will void any guarantee over the product.



- **Applications onto oil contaminated substrates**

- (i) Removal of oil is mandatory to ensure proper bonding of Jotafloor PU Crete. Apart from debonding it can also cause fish eyes and stains appearing on the applied area.
- (ii) To remove oil from the substrate and if the penetration has been for shorter duration, use a neutral detergent and scrub onto the stained concrete. Do not use solvents as they carry the oil deeper into the concrete. Evaluate if any more oil is leaching up to the surface and if so, repeat as necessary. It is always recommended to do an on-site reference area to confirm compatibility, method of preparation and acceptable final application results.
- (iii) To remove oil from the substrate and if the penetration has been for longer periods, it is advisable to burn the substrate using a flame torch or LPG burner and repeat as mentioned in clause (ii).

- **Applications onto concrete substrate soaked with blood**

- (i) The presence of blood and organic material will result in failures due to the possible growth of bacteria and supported by the moisture present in the substrate.
- (ii) For such areas concrete must be thoroughly cleaned using a solution as mentioned below. It should be further scarified using a scarifier prior to the application.
- (iii) For cleaning
 - a) Wash the floor with sodium hydroxide diluted in water (1:3) at ambient temperature.
 - b) Neutralize with hydrochloric acid in water (1:3). Citric acid can be also used.
 - c) Rinse with water at ambient temperature the following day, to remove the salts that will be formed.
 - d) Repeat the process until it is confirmed that the contamination has been fully eliminated. (it is difficult to ascertain completely due to the porous nature of concrete)
 - d) Ensure the substrate is completely dry until fully achieving the acceptable moisture content.
 - e) Scarify the substrate to create adequate surface profile.

- **Working in Food and Beverage**

- (a) When installing Jotafloor PU Crete flooring in operational food factories, attention must be paid to work in a clean and systematic manner and reduce the impact on surrounding areas.
- (b) We must ensure thorough protection of floors and walls along the exit routes work area and the mixing station. Additionally, we must ensure that drainage elements are closed and protected from mechanical damage.
- (c) The customer must be informed of the risk of contamination from dust during installation.
- (d) We should discuss the process of application in detail with the customer to minimize any risk.
- (e) The location of the mixing station should be such that any dust generated or cleaning solvent vapors are localized.

- **Falls in floor finishes**

- a) Falls or slope on the floor should be designed to drain the water from the floor to the drainage.
- b) The amount of slope varies from floor to floor, but all floors with drains follow the same basic principles as part of the installation.
- c) Jotafloor PU Crete installer in consultation with the civil contractor should agree that suitable falls ensures the drainage of water every time to avoid ponding. A properly designed slope will carry all water and moisture down to the drain and away from the finish surface.
- d) This is important to food safety because pools of water are not allowed in food factory floors. They also affect the lifespan of the floor surface.



IMPORTANT PRECAUTIONS AND SPECIAL CONSIDERATIONS



IMPORTANT PRECAUTIONS AND SPECIAL CONSIDERATIONS :

- **Conditioning of the materials**



a) After transportation, allow the material to acclimatize to ambient temperature for at least 24 to 48 hours. This is because during transportation the materials may be exposed to extreme (high or low) temperatures which will negatively impact the workability if used immediately.



b) When working at high temperatures, it is necessary to cool the material prior to its application in order to increase the working and open time, reducing the chance of blistering due to excessively fast skin formation.

c) If applications are to take place in extreme temperatures above 27 degrees Celsius conditioning of the material to the intermediate temperature range (15°C to 23°C) is advisable in order to ensure enough working time, proper consistency and reduced potential for failures caused by application under inadequate conditions.



Placing parts A and B in ice cubes will help bring its temperature down. Please ensure that the Part B does not come in contact with ice/water as it can have a negative reaction. The mixed temperature of component A and B should be not be less than 15 degrees. It is better to check the temperature using a thermometer before carrying out the application.



d) While the temperature is 15 degrees Celsius or less, it is important to raise the temperature of the stocked material. The entire materials required for application can be placed under a tent or a covered area and can be heated using electrical radiators or hot air blowers.

- **Shelf Life**

- (a) Jotafloor PU Crete has a definite shelf life and is dependent upon storage conditions.
- (b) If the materials are used after the shelf life has lapsed the results will not be satisfactory with visible blisters and cracks on the final finish.
- (c) Shelf life of Jotafloor PU Crete is 6 months.

- **Stocking of the Materials**

- (a) Jotafloor PU Crete must be protected from frost, moisture and direct sunlight.
- (b) Store the product in a dry, shaded area, protected from rain and direct sunlight and other external heat sources
- (c) Please ensure component C is always kept on a raised platform ensuring that it is not in direct contact with the floor.



SURFACE PREPERATION



SURFACE PREPARATION:

- **Anchor Grooves**

- Saw cut Anchor/Retaining grooves to prevent curling of the Jotafloor PU Crete during hardening and curing of the coating.
- Open the grooves twice as wide and deep as the Jotafloor PU Crete thickness. Use a suitable double blade saw with connection to an industrial vacuum cleaner.

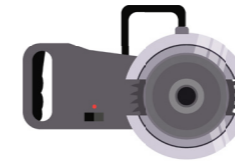

- Open the grooves wherever a free edge of the PU Crete is possible. Also, wherever there is a discontinuity in the Jotafloor PU Crete that will occur like around the perimeter of a bay, along channels, drains or expansion joints, at doorways, around the feet of machinery, plinths and columns.
- A minimum 5 cm distance is recommended from the perimeter of the walls.
- The maximum distance between anchor grooves in either direction is 16 m. If the floor is larger than 16 m on either side, then extra anchor grooves will be needed to be provided. If the floor size is less than 16 m on either side it is still necessary to provide anchor grooves at the corresponding distance.

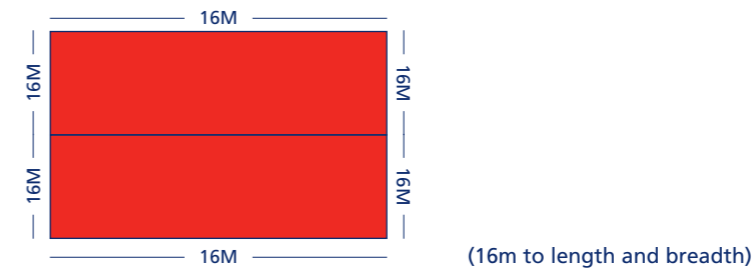

- If the room is too large to complete in a single working day then the PU Crete should end at an anchor groove (Day joint). The following day's work should start at the next anchor groove. This can be decided in advance and should be cut once the days work is planned.
- Jotafloor PU Crete should not be carried through a door without anchor grooves across the doorway. The external corners of the doorways especially when the wall is cast into the floor should have an extra 45-degree groove cut coming out from the external corner which should continue into the floor twice the width of the wall structure. If the width of the wall is 50 mm then the anchor groove should be 100 mm.

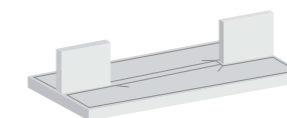

Anchor grooves at door



Scratchcoat applied



Final body coat applied

h) Two lines of anchor grooves around drains should be created. The first one as close as possible to the drain which will accommodate a sealant and the second 50 mm away from the drain to anchor Jotafloor PU Crete.

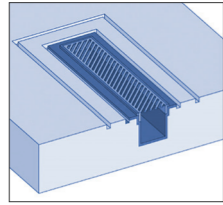

Set out showing anchor groove along edge of drain and secondary groove

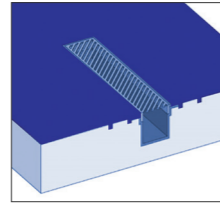

Finished floor showing the filled anchor grooves.

• **Coving**



- The floor to wall joint cove is highly critical for successful applications.
- Coving can be laid using Jotafloor PU Crete Cove.
- We recommend that coving be laid prior to the application of Jotafloor PU Crete.
- Use a coving trowel for laying of the cove.
- A dual anchor groove should be prepared. One very near from the wall to anchor Jotafloor PU Crete cove and the other anchor groove to hold Jotafloor PU Crete. The width and depth of the anchor groove should be twice the thickness of Jotafloor PU Crete.
- After curing of the Jotafloor PU Crete cove apply the Jotafloor PU Crete.

• **Expansion Joints**

- (i) Expansion joints on the floor must continue through the Jotafloor PU Crete and should be filled with flexible sealant.
- (ii) For better and stronger edges of expansion joint it is best to saw cut the material after application. This will produce a more uniform joint when compared to one made by placing a piece of wood in the concrete and applying the Jotafloor PU Crete to either side.
- (iii) There are few areas where it is advisable to deliberately create expansion joints as these areas will be subjected to thermal or vibrational movements during service.
 - (a) Boundaries between different floors or flooring materials
 - (b) Load bearing columns on the floor
 - (c) Areas around ovens, freezers and other equipment's which are subjected to high temperatures can cause thermal stress.
 - (d) Cold storage rooms should be separated from a surrounding room by expansion joints. Inside the cold storage rooms if the concrete floor is not laid on an insulating layer then an additional movement joint (provide anchor groove as mentioned under induced movement joint) will be necessary inside the cold room.
- (iv) Expansion joints must always be filled with a suitable flexible joint sealant. The best joint sealant for any application will depend upon the width of the joint and the amount of anticipated movement as well as the chemical nature and temperature of any spillages likely to impact the floor.
- (v) Anchor grooves should always be created at termination like expansion joints. It is important to provide the groove next to the expansion joint to anchor the Jotafloor PU Crete. The groove should be twice the width and depth of PU Crete.

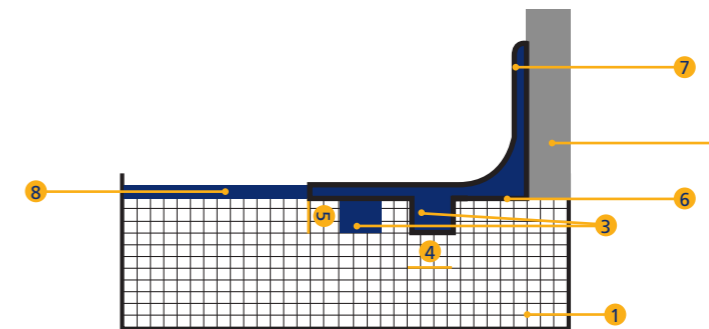

1. Concrete Slab
2. Wall or Concrete
3. Anchor Grooves
4. Width - 2 x PU Crete thickness
5. Depth - 2 x PU Crete thickness
6. Jotafloor PU Crete Cove
7. Optional stop bead
8. Jotafloor PU Crete

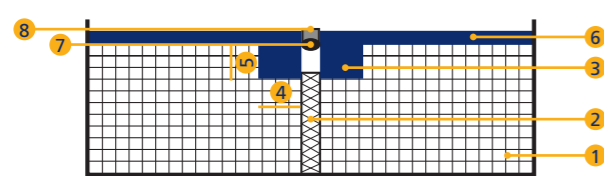

1. Concrete Slab
2. Expansion Joint
3. Anchor Grooves
4. Width - 2 x PU Crete thickness
5. Depth - 2 x PU Crete thickness
6. Jotafloor PU Crete
7. Packer Rod
8. Joint Sealant

• **Termination of Wall**

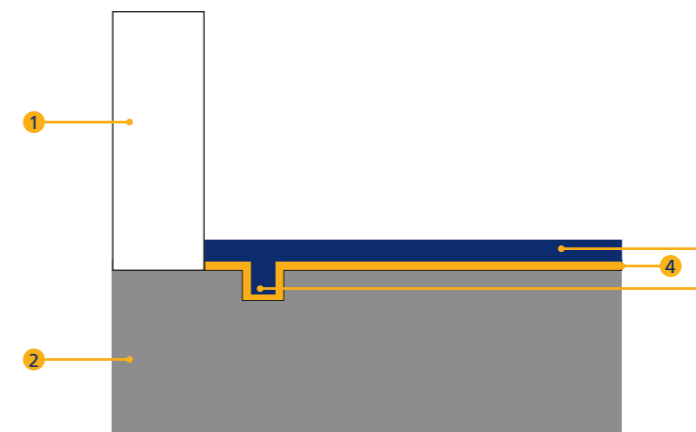

1. Wall
2. Concrete
3. Jotafloor PU Crete
4. Jotafloor PU Crete Scratch Coat
5. Anchor Grooves
Width - 2 x JF PU Crete thickness
Depth - 2 x JF PU Crete thickness

• **Control joints or Induced Movement joint**

- (i) Movement joints are provided on to floor to accommodate movements especially if the expansion joints are not placed at sufficient distances.
- (ii) The depth of the movement joints should be ¼ th of the concrete screed thickness. The width should be a minimum of 5 mm to accommodate the sealant.
- (iii) Anchor groove should be provided at 50 mm from the movement joint to hold the Jotafloor PU Crete. (see the graph below)

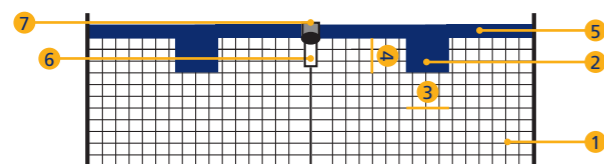

1. Concrete Slab
2. Anchor Grooves
3. Width - 2 x PU Crete thickness
4. Depth - 2 x PU Crete thickness
5. Jotafloor PU Crete
6. Saw cut in concrete screed
7. Joint sealant with packer road

• Termination at free edge

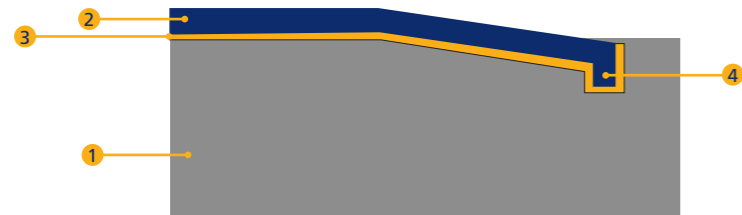

1. Concrete
2. Jotafloor PU Crete
3. Jotafloor PU Crete Scratch Coat
4. Anchor Grooves
Width - 2 x JF PU Crete thickness
Depth - 2 x JF PU Crete thickness

• Stainless Steel

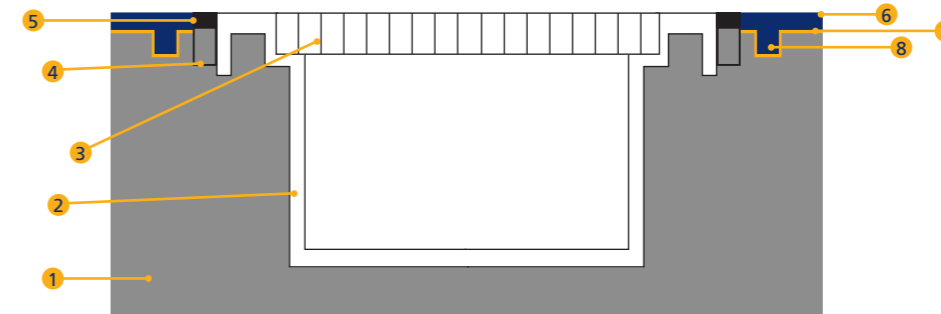

1. Concrete
2. Steel Channel
3. Grating
4. Backing Rod
5. Joint Sealant
6. Jotafloor PU Crete
7. Jotafloor PU Crete Scratch Coat
8. Anchor Grooves (Saw Cut)

• Cove to kerb

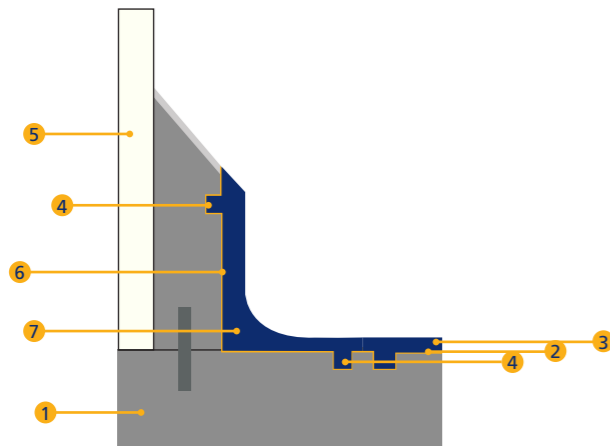

1. Concrete
2. Jotafloor PU Crete Scratch Coat
3. Jotafloor PU Crete
4. Anchor Grooves (Saw Cut)
5. Insulation Panel
6. Jotafloor SFPR 150
7. Jotafloor PU Crete Cove

• Surface Preparation and concrete repairs

- (i) The concrete substrate must be sound and of adequate compressive strength (minimum 25 N/mm² or 3626 psi) with a minimum cohesion (pull off strength) of 1.5 N/mm² or (218 psi).
- (ii) The surface must be clean, dry or saturated surface dry and free of all contaminants, e.g. dirt, oils, grease, coatings and surface treatments, etc.
- (iii) Jotafloor PU Crete can be applied onto fresh concrete (7 to 10 days old) and the moisture content should be less than 8%.
- (iv) Concrete substrates must be prepared mechanically using captive blasting machine or scarifying equipment or appropriate diamond disc grinder to create high profile to remove cement laitance and achieve an open textured surface to achieve CSP 3-9 according to the International Concrete Repair Institute.

Flooring Type	Concrete Surface Profile									
	CSP 1	CSP 2	CPS 3	CSP 4	CSP 5	CSP 6	CSP 7	CSP 8	CSP 9	
Sealer < 150 µm	█									
Thin Film 150-300 µm	█									
High Build 300-1000 µm			█							
Self Smoothing 2-3 mm				█						
Screed Overlays 3-6 mm					█					



• Applications over plinth

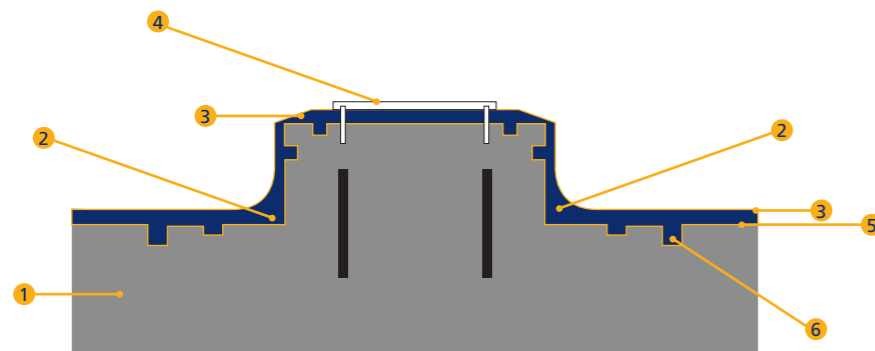

1. Concrete
2. Jotafloor PU Crete Cove
3. Jotafloor PU Crete
4. Machinaries
5. Jotafloor PU Crete Scratch Coat
6. Anchor Grooves (Saw Cut)

- (v) Weak concrete must be removed, whether manually or mechanically and surface defects such as blow holes and voids should be fully exposed.
- (vi) Repairs to the substrate the blow holes and voids up to 10 mm can be carried out with Jotafloor PU Crete during scratch coat.
- (vii) Areas to be repaired that are greater than 10 mm should be filled with a slurry (combination of Jotafloor SF PR 150 and non-slip aggregate medium 0.3 mm – 0.6mm in a ratio of 1Ltr:7Kgs). Ensure that after drying of slurry the surface should be levelled using a disc grinder.
- (viii) All Shrinkage cracks should be opened and should be filled with Jotafloor PU Crete as a scratch coat.
- (ix) In order to prevent the visibility of the cold joints on the surface we must ensure that the joints must be filled with Jotafloor PU Crete during scratch coat.



PACKING AND COVERAGE



PACKING AND COVERAGE:

Description	Components	Standard Packaging	Thickness	Theoretical Coverage
Anti-microbial Medium Duty self -smoothing solvent-free polyurethane.	Comp A: Resin	2.49 Kg/2.49 L	4 MM	0.25 sqm/litre
	Comp B: Hardener	2.96 Kgs/2.41L	5 MM	0.20 sqm /litre
	Comp C: Filler	14.55 Kgs/5.30 L	6 MM	0.16 sqm /litre
	Comp D: Pigment	0.49 Kgs/0.43 L		
		Total 20.46 Kgs/10.63 L		



MIXING



MIXING:

- (a) Provide adequate protection around the mixing areas to prevent contamination of the concrete underneath. Plastic sheet or cardboard should be placed to protect the floor around the mixing areas.
- (b) Cover the prepared substrate prior to application with plastic sheet to avoid spilling of materials to prevent outgassing and bubbling. Avoid mixing under direct sunlight.
- (c) A slow speed mechanical mixing agitator with a speed of 300- 400 rpm shall be used for mixing.



- (d) When using mixing drills use an appropriately sized bucket to ensure the mixing head is fully submerged to avoid entrapping too much air. If the bucket is too big for the volume of material then mixing efficiency will be poor.
- (e) Stir comp A separately and add Comp D. Further add Comp B to the mixture and continue mixing. Ensure that the speed is consistent at 300-400 rpm.
- (f) Next add Comp C to the original mixture and continue the mixing. Ensure the comp C is released gradually. Allow part C to blend for a further minimum of 2 minutes to ensure a homogenous mix is achieved.
- (g) During the operations, scrape the sides and bottom of the container with a flat or straight edge trowel to ensure complete mixing.
- (h) Next empty the complete mix into a third container to ensure that the Comp C is consistently mixed. This must be done to ensure that the white lumps from Comp C is not visible on the coating.
- (i) It is important that the final mixing of all the 4 components is done at slow speeds (300-400 rpm) to avoid the entrapment of air and the risk of random blistering. Improper mixing may lead to poor flow, trowel marks, blisters and undulations
- (j) Mix full units and no part mixing is allowed.
- (k) It is important that the mixed PU Crete is laid on the floor immediately and that mixing of the subsequent batch starts straight away. This ensures good consistency between mixes.
- (l) Application of Jotafloor PU Crete below 15 degrees Celsius will make application more prone to problems. Careful consideration should be given to storage of materials in cold conditions.
- (m) Temperature requirements: The site temperatures for application should be 15 – 27°C and the material temperatures after mixing should be 15 – 22°C.
- (n) When discharged from the mixer Jotafloor PU Crete should be at least 15°C.

Mixing at temperature below 20 degrees C

Ideally it is best to mix for 3 minutes (including the time for adding comp C). Ensure that all the components are thoroughly mixed.

Mixing at temperature above 20 degrees C

Ideally it is good to mix for 2 minutes (including the time for adding comp C). Ensure that all the components are thoroughly mixed.



SHADE VARIATIONS



SHADE VARIATIONS:

- Use the components of the same batch for a particular area to eliminate the risk of shade variations.
- To maintain consistency adjacent areas should be laid with components of the same batch.
- Ensure a consistent mixing time and application is followed.
- Ensure sufficient labor is available on site to install the product properly.
- Jotafloor PU Crete, upon exposure to sunlight, will change its color but it does not affect the product performance.

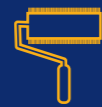

APPLICATION



APPLICATION:

(a) Important factors to note before application

(i) Jotafloor PU Crete is a fast curing coating and has a pot life of maximum 10 minutes at 23°C and will decrease at higher temperatures. When the coating is worked upon after 10 minutes the appearance of the finished coating may be damaged.

(ii) It is advisable to lay the coating in bays, with the width of each bay being a maximum of 6 mtrs so that the mixed coating can be easily spread.

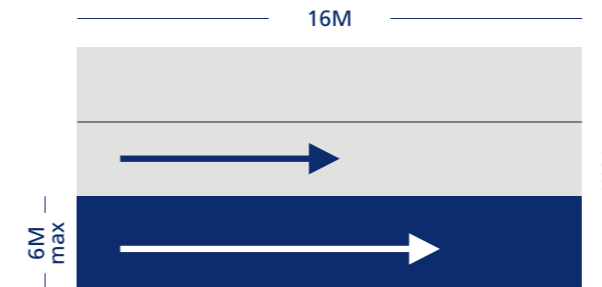

(iii) Once a bay is laid ensure that the applied previous bay is not touched again as it can damage the final appearance.

(iv) Ensure that there are more than one mixing agitator if the area is large and also enough manpower to carry mixing and application. Any delay would cause the visibility of the joints.

(v) It is important that the application is planned so that the junction between the various bays of a large floor can be placed in the optimum locations to give the best aesthetic result. These junctions can be made to coincide with joints or hidden under a plant or machinery. It is ideal to avoid many junctions in main traffic areas where it will be seen. These joints are inevitable and cannot be avoided.

(b) Tolerances

Jotafloor PU Crete will correct the tolerances up to 6 mm. It is better to maintain the substrate to the appropriate tolerance levels prior to the application of PU Crete.

(c) Priming and scratch coat

(i) Substrate sealing is normally not required if the concrete is not porous. In such cases a scratch coat of Jotafloor PU Crete can be applied directly. In case the concrete is highly porous we recommend a coat of Jotafloor SF PR 150 to be applied @ 5 sqm/ litre.

(ii) Insufficient curing of primer before over coating can cause delamination at lower temperatures.

(iii) Due to variations in concrete quality, substrate conditions, surface preparation and ambient conditions, reference test areas are recommended to determine whether priming is required to prevent the possibility of blisters, de-bonding, pinholes and other aesthetic variations.

(iv) Jotafloor PU Crete scratch coat should be applied at 1 sqm /litre to achieve a thickness of 1 mm. This is to produce a smooth and sealed substrate for the application of the finished coat and ensure the best aesthetic results.



- (v) Ensure the Jotafloor PU Crete scratch coat is properly cured and dry to the touch before application of the finished coat. If the time between coats exceeds 48 hours, or if condensation or water impacts the surface then it is required to do light grinding to abrade the surface prior to overlaying.
- (vi) Ensure that all the anchor joints created should be filled only partially while applying the scratch coat so that some part of the joint is visible while applying the finished coat.

(d) Finished Coat

(i) Spread the mix evenly over the substrate using a notched trowel. Additionally, use a steel trowel for edgework.

<u>Dry Film thickness (DFT)</u>	<u>Coverage/ litre</u>	<u>Theoretical Coverage/kit</u>
4 MM	0.25 sqm	2.66
5 MM	0.20 sqm	2.13
6 MM	0.17	1.81



(ii) Use a spiked roller to produce a smooth even finish. The whole floor should be spike rolled twice only.



(iii) On the first pass the spiked roller should be pushed right through the depth of the coating to assist the flow, remove notched marks and to level the floor.

(iv) During the second pass ensure the roller is not forced into the coating to provide a perfect finish.

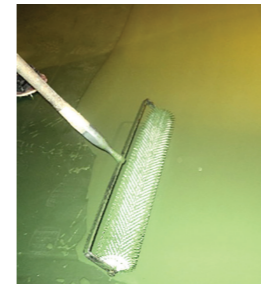

- (v) To ensure an even finish all spike rolling and use of trowel should be completed before the mix is more than 10 minutes old at 23°C.
- (vi) Avoid throwing resin onto the already scattered floor by too aggressive use of the spiked roller as this will create surface defects.
- (vii) Avoid the rolling on to previous applied area to protect the floor from any gloss and color variations. The spike marks also tend to remain on the final finish.

(e) Repairs

- (i) Using an angular diamond blade cut around the perimeter of the area to be repaired.
- (ii) Using a hammer and chisel remove the damaged coating and clean the surface and ensure the area is free of all dust and debris.
- (iii) It is necessary to create a groove around the perimeter of the to be repaired area to anchor the repaired material.
- (iv) Proceed with the scratch coat and then the finished coat as mentioned under application.
- (v) Later just adjacent to the groove saw cut again and fill the joint with a PU sealant. (see the pic below)

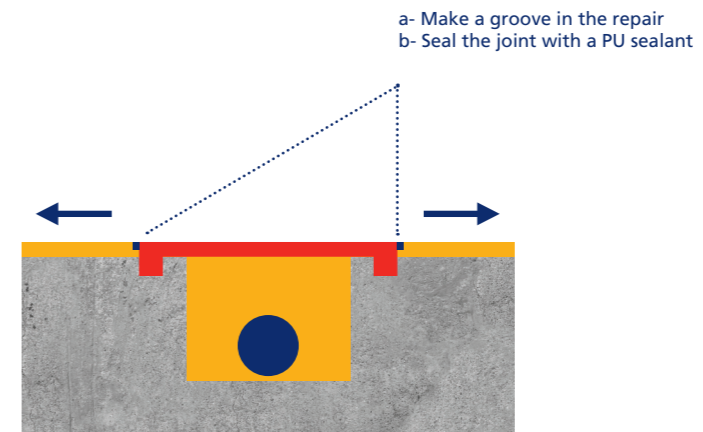



EQUIPMENT

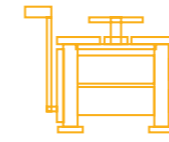

EQUIPMENT:

Tools and equipment required for substrate preparation



Scarfing



Captive Blasting Machine



Diamond Disc Grinder



Hand Grinder



Industrial Vacuum



Mixing Agitator



Double Saw Blade



Spiked Shoes



Notched Floor Coating Rake



Spiked Roller



Moisture Meter



Steel Trowel

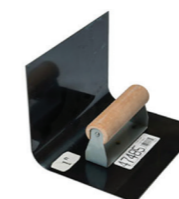

Coving Tool



Foam Tape



Dew Point Meter



COLOURS



COLOURS:

Jotafloor PU Crete are available in these 5 standard colours.
Colours shown are approximate, actual colour may vary in actual site conditions.
For further information and product samples, please contact your local Jotun office.

RED



GREEN



YELLOW



LIGHT GREY



DARK GREY





APPLICATION MISTAKES AND SURFACE DEFECTS



APPLICATION MISTAKES AND SURFACE DEFECTS:

An overview of few possible defects which can be eliminated by following the recommendations in TDS and Method statement.

1. Curling

Reason: Absence of anchor grooves.

Importance: Critical

Repair methodology: remove the existing coating, open grooves and recoat with Jotafloor PU Crete

Prevention: Follow the method statement.

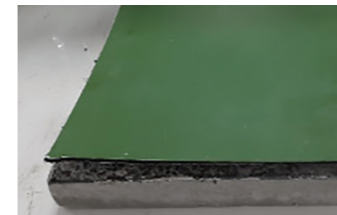

2. Spike Roller Marks

Reason: Excessive back-rolling and spiking.

Importance: Critical

Repair methodology: Grinding and application of Jotafloor PU Crete.

Prevention: Ensure only two passes of the spiked roller.

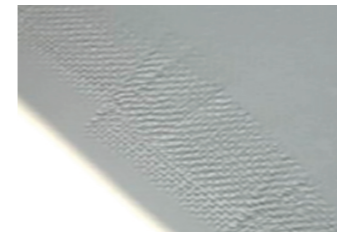

3. Random Blistering

Reason: Generally at high ambient and storage temperature, application under direct sunlight and over coating even when the surface is tacky.

Importance: Critical

Repair methodology: Localized repair and application

Prevention: Condition of the relevant components.



4. Blistering

Reason: Exceeding the shelf life of component C and hydration.

Importance: Critical

Repair methodology: Grind and recoat the damaged area.

Prevention: Proper storage of Comp C and usage within the shelf life.



5. White Bloomy Surface

Reason: Poor ventilation or low humidity

Importance: Minor

Repair methodology: Grind and recoat with Jotafloor PU Crete.

Prevention: Ensure adequate ventilation is during and after the application.

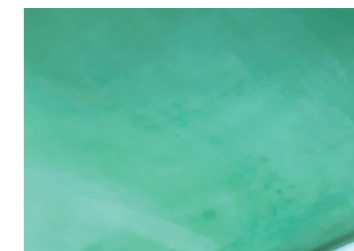

6. Delayed Drying or Curing

Reason: Improper mixing

Importance: Critical

Repair methodology: Remove and then recoat with Jotafloor PU Crete.

Prevention: Experienced workman ship.



HSE



HEALTH AND SAFETY:

Please observe the precautionary notices displayed on the container. Use under well ventilated conditions. Do not expose to powder components while mixing. Avoid skin contact. Spillage on the skin should immediately be removed with suitable cleanser, soap and water. Eyes should be well flushed with water and medical attention sought immediately.





PPE



PPE:

Eye protection, protective clothing and gloves should be worn by all personnel handling Jotafloor PU Crete. In addition, personnel handling Component C should mandatorily wear dust masks. Similarly, personnel engaged in surface preparation and hand grinding should also wear dust masks.



Solvent and Paint Resistant Gloves



Safety Glasses



Dust Mask



Helmet



Safety Shoes



Coverall



CLEANING AND MAINTENANCE



CLEANING AND MAINTENANCE:

To maintain the appearance of the floor after application, Jotafloor PU Crete must have all spillages removed immediately and must be regularly cleaned using rotary brushes, mechanical scrubbers, scrubber driers, high pressure washers, wash and vacuum techniques, etc., using suitable detergents.

Maintenance

If the correct cleaning and maintenance schedule is used, the appearance of your floor can be easily maintained.

- Sweep floor to remove loose debris and accumulations of soil.
- Use the appropriate cleaning agent - detergent, degreaser, emulsifier, etc., or combination of agents.
- Regular washing with a suitable washer/drier machine should normally be carried out using a low foam neutral detergent.
- Apply cleaning agent (or combination of agents) diluted as required in the on-board detergent tank and allow it to react on surface.
- Agitate by mechanically using the floor scrubber.
- Remove dirty water with wet vacuum.
- Observe all regulations, which prohibit introduction of certain chemical cleaners, solvents and wastes into surface water drains, sewer systems, open bodies of water or into the soil.
- Rinse and scrub again and vacuum clean and dry.

General Tips & Advice

✓ DO

- Initial clean before use and take care when installing equipment
- Clean regularly
- Consider giving a higher frequency of maintenance to heavily trafficked areas (e.g. entrances) where the levels of grit, dirt and wear are highest.
- Clean up spillages immediately.
- Remove traces of oil and grease immediately with an aqueous solution of alkaline detergent.
- Ensure that cleaning and maintenance levels are higher in areas subject to accidental contamination by chemicals or bacteriological materials.
- Use the best quality equipment for cleaning.
- Ensure that cleaning equipment is regularly cleaned.
- Follow the instructions provided in Jotun maintenance guide.

✗ DON'T

- Use excess concentrations of cleaning agents
- Mix cleaning chemicals and agents - this can also be harmful.
- Use excessive water.
- Use solvents.
- Use phenol-based cleaning chemicals - they will cause degradation of resin floor surfaces.

CAUTION:

This product is for professional use only. The applicators and operators shall be trained, experienced and have the capability and equipment to mix/stir and apply the coatings correctly and according to Jotun's technical documentation. Applicators and operators shall use appropriate personal protection equipment when using this product. This guideline is given based on the current knowledge of the product. Any suggested deviation to suit the site conditions shall be forwarded to the responsible Jotun representative for approval before commencing the work.

DISCLAIMER:

The information in this document is given to the best of Jotun's knowledge, based on laboratory testing and practical experience. Jotun's products are considered as semi-finished goods and as such, products are often used under conditions beyond Jotun's control. Jotun cannot guarantee anything but the quality of the product itself. Minor product variations may be implemented in order to comply with local requirements. Jotun reserves the right to change the given data without further notice. Users should always consult Jotun for specific guidance on the general suitability of this product for their needs and specific application practices. If there is any inconsistency between different language issues of this document, the English (United Kingdom) version will prevail.



Jotafloor

Jotafloor PU Crete is just one of our many products in the Jotafloor range of coatings. These range of products were created due to our wealth of expertise in the protection and decoration of concrete. This considerable knowledge was formalized in a range of floor protection products known as Jotafloor. This range offers solutions that provide lasting protection and beauty on new projects or the repair of concrete and its maintenance.

The Jotafloor range of products and systems are able to protect and extend the life of floors through certain protective qualities. These qualities can safeguard against chemical spills, heavy traffic, abrasions and other impacts, whilst providing a range of colours that are aesthetically pleasing.



GET IN TOUCH

At Jotun, our aim is to do more than just sell you a superior performing product. With industry-leading technical assistance and a track record of global market experience, we can also partner with you to provide solutions that meet your operational goals.

Please get in touch with your local representative so that we can tailor a solution that's right for you.

[JOTUNPROFESSIONALS.COM](https://www.jotunprofessionals.com)



Jotun Protects Property